

# MYTHOS SUPERSHARP



CLAY PAKY

CLAY PAKY

CLAY PAKY

AN OSRAM BUSINESS

CLAY PAKY  
AN OSRAM BUSINESS





Fritz Kalkbrenner on Tour with the Mythos



**MYTHOS**



**SUPERSHARPY**

## THE NEW GENERATION OF CLAY PAKY LIGHTS

Mythos and SuperSharpy are a new generation of Clay Paky lights that not only features a new look, but has also been designed and built to make the lights easier to manage and maintain and their functions easier to use. Mythos and SuperSharpy feature a previously unimaginable number of lumens for each watt consumed; they are capable of very rapid precise pan-tilt movements and effect changes, and have an advanced set of pre-programmed functions just waiting to be discovered!



# MYTHOS



## PUT AN INNOVATIVE "HYBRID LIGHT" TO THE TEST

The Mythos is the most advanced kind of hybrid light: one that performs each function excellently without compromise. Firstly it is a top-ranking spotlight, with a dense light beam and a zoom that ranges from 4° to 50°. However the Mythos is also an extraordinary beamlight with an optical unit capable of reducing the beam angle to only 2.5°, thus creating a parallel

light beam that can reach hundreds of yards, even without smoke effects. These two operating modes do not interfere with each other. The Mythos is not a spotlight that can also be used as a beamlight, or vice versa: it is a spotlight and beamlight in one and both modes perform to the full extent! If you are a lighting designer, the Mythos is a versatile tool you can use in

different ways in your shows for: spectacular midair 3D effects; beams with impressive beam angles; razor sharp, dynamic projected visual effects; bright tubes of light that penetrate the air. If instead you are a rental company, the Mythos is the best investment you can make: you will have an unbeatable frequent use product.



## AMAZING LUMINOUS EFFICIENCY

What will surprise you most is the Mythos' extraordinary luminous efficiency. Its discharge lamp consumes only 470 watts, but its light output is comparable with a 1500-watt discharge spotlight, and even more! In other words it has an exceptional lumen to watt ratio, which means considerable savings in terms of operational management and energy. No LED spotlight is on a par with it: the Mythos is about three times brighter than a LED spotlight with the same energy consumption and is quite definitely smaller and lighter.

Light Source	MSD Platinum 20R
Power Consumption	470 W
Color Temperature	7,800 K
Luminous Flux	23,000 lumen
Nominal Life	1,500 h
Socket	Faston TM 250 (6.35 mm)



## COMPACT, HARD-WEARING AND DESIGNED FOR SAVINGS

The Mythos is built for heavy duty and demanding use. It is compact, but at the same time very sturdy, and weighs only 31 kg / 68.2 lbs. Its elegant design is enhanced by a unique surface finish with a pleasant hi-tech texture. The Mythos is easy to move about and handle on stage, and simple to hoist and install. Thanks to its small size, it leaves room for other appliances on the rig. It

takes up very little space on vehicles and in warehouses. All this means low operating costs and energy savings, without having to compromise on features and thrills.



## NEXT GENERATION OPTICS ALREADY AT YOUR SERVICE

What really matters with a lighting fixture is the light it produces. However you will also be glad to know that the Mythos' efficiency stems mainly from its sophisticated optical unit. Its first distinguishing feature is its big 160 mm (6.3") diameter front lens, which produces a large beam that can be seen from afar and at any beam angle. Everyone will be surprised that such a small light can produce such a substantial beam. The three lenses in the optical unit focus maximum luminous efficiency right on the effect you want to project, and the edges of the light beam remain sharp for its en-

tire length, from the front lens to infinity. This exclusive feature allows the beam to penetrate the air and gives it an almost three-dimensional look. In addition, the light can also be programmed to focus automatically. Clay Paky's expertise in micromechanics has given rise to a fast accurate zoom, which ranges from 4° to 50° (1:12 ratio). The Mythos is therefore perfect in every situation: from large open air shows to small TV studios or exhibitions. The zoom movements are smooth and accurate, so much so that they can be used on their own as effects.



The edges of the light beam remain sharp for its entire length, from the front lens to infinity.



### Mythos in comparison with a 1500W spotlight

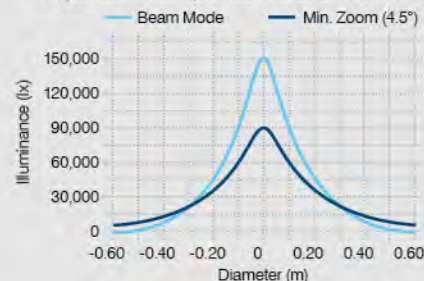

Mythos illuminance distribution  
Distance 20 m

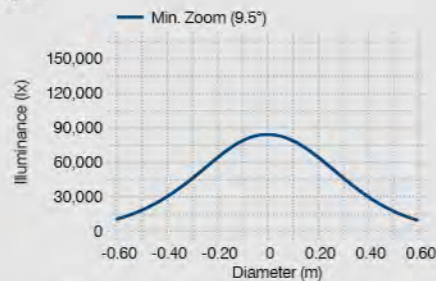

Alpha Spot HPE 1500 illuminance distribution  
Distance 5 m

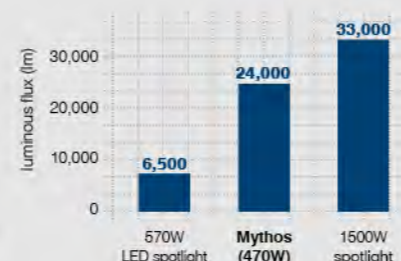

Average luminous flux

At minimum zoom, illuminance values of Mythos light beam's centre at 20m are comparable to Alpha Spot HPE 1500's values at 5m!

Mythos' 470W discharge lamp delivers more lumens than a 570W LED spotlight!

### MYTHOS - Photometric Diagram

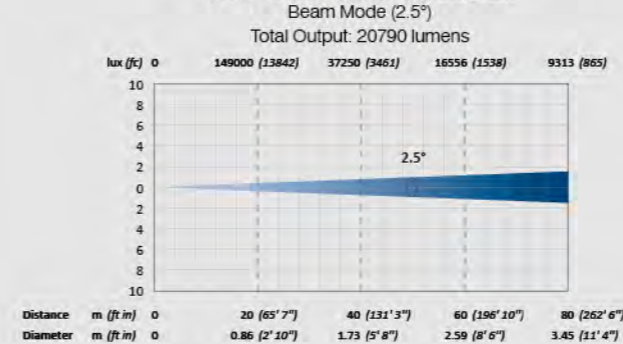

Six narrow beam angles (from 0° to 2.5°) can be obtained by using beam reducers

### MYTHOS - Photometric Diagram

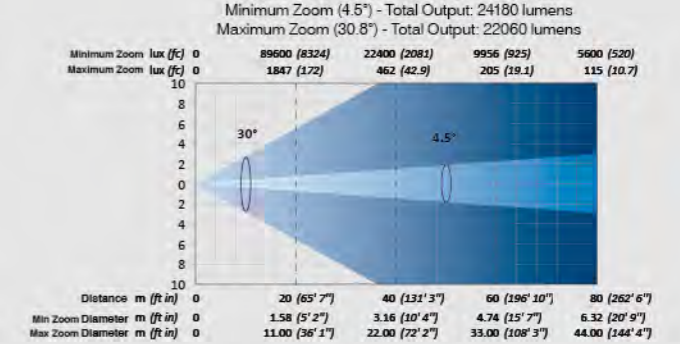

Beam angle can reach 50° on rotating gobos and animation disc projections



## UNIQUE 3D LIGHTING EFFECTS FOR UNLIMITED CREATIVITY

The Mythos' great versatility as a creative tool stems from the expressive capacity of its light beam. It is not just a precise tool for projecting beautifully sharp images on surfaces, but it can also fill the atmosphere at the same time with dense three-dimensional beams that change shape dynamically unlike any other light on the market. The number of effects that shape the beam is important. There are 18 fixed metal gobos and 6 rotating dichroic gobos with high-definition graphics. There is also a special visual effect disc, which may be used in conjunction with the gobos to animate the projected images. This disc may also be used alone to produce spectacular

effects by adjusting its focus, its partial insertion and its two-way rotation at different speeds. When the animation disc is used against the light with smoke in the air, it produces a highly impressive midair "shutter" effect. There are also two indexed rotating prisms, which multiply the projected images. The first is a four-way prism which diffuses the light in all directions filling all the available space. The second is linear and fans the light beam out. All these effects may be combined with each other, thus increasing the lighting designer's creative possibilities endlessly.



### Fixed Gobo Wheel



### Graphic Disc



### Rotating Gobos Ø 25.9 mm - img: Ø 13 mm

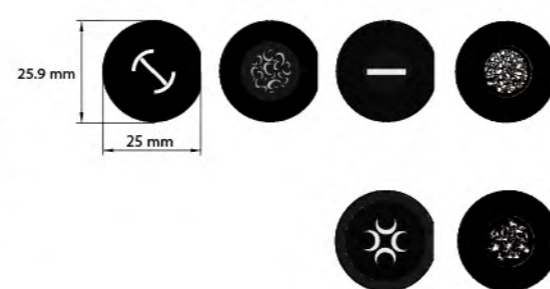

## ENDLESS COLORS AND... A WASH EFFECT!

The Mythos is equipped with a gradual-insertion CMY system, which also features fixed colors that may be overlapped and used to generate a two-colored light beam. CMY mixing ensures a very smooth transition from one color to another. Two color temperature conversion filters (3200 and 2500 kelvins) add infinite shades of color, especially pastel shades. The fixed colors available are: light orange, dark orange, aquamarine, pink, light

green, dark green, dark blue, half minus green, dark red, lavender and blue wood.

A frost filter can be used both to soften the edges of the spotlight and simulate a washlight.

### Color Wheels and CMY System

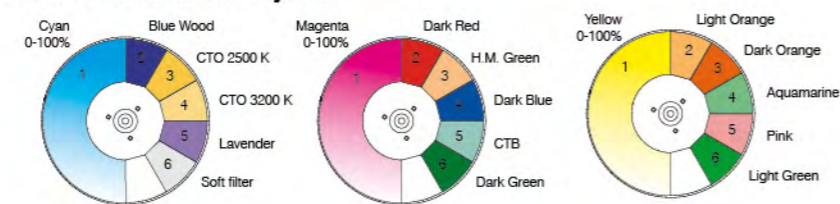

## MYTHOS' MAIN BENEFIT: VERSATILITY

The Mythos is able to combine the visual effect capabilities of a powerful spotlight with the midair effects of a powerful beam light seamlessly

into a single unit. The Mythos is a very versatile tool, which is useful in any situation and therefore an excellent investment. Clay Paky has yet again

developed an exemplary light in terms of light output: it is able to generate a previously unimaginable number of lumens for each watt consumed.



## A THICK PARALLEL BEAM THAT CUT THROUGH THE AIR

The Mythos can go from spotlight mode to beam mode instantaneously. The fixed beam angle is only 2.5°. A very dense, big 160 mm / 6.3" diameter beam leaves the large front lens and remains parallel for its entire length

up to great distances. The beam diameter may however be reduced using six beam diameter reducers available on the fixed gobo wheel (from 0° to 2.5°). When the Mythos is used as a beam-light, it is two and a half times brighter

than a Clay Paky Sharpy (149,000 lx vs 60,000 lx at 20 meters / 22 yards). The fixed gobos can be focused to shape the light beam in midair. The animation disc may be inserted to fill the atmosphere with striking effects.





# SUPERSHARPY



## THE MOST EFFICIENT BEAM MOVING LIGHT EVER

The Supersharpy is the most efficient beam moving light in the world in terms of brightness. It features a 470 watt lamp, but is able to produce an incredible 165,000 lux at 20 metres (almost 22 yards). No other light with the same rated power even approaches this figure. The light beam is up to three times brighter than the famous Sharpy: a

much greater difference than you would expect simply by comparing the wattage of the two lamps (470 vs. 190). Thanks to this incredible power, the Supersharpy's light reaches never-seen-before distances, making the Supersharpy the first low-watt beam moving light able to compete with searchlights. The Supersharpy is a must-have invest-

ment for large live events, where midair tracer beams, visible hundreds of yards away, are often the mainstay of the lighting design. It can also be used successfully during anniversary celebrations and historical and cultural events, in large showrooms, at corporate conventions, and as lighting to call attention to large venues or shopping centres.



## QUALITY LIGHT AND LOADS OF EFFECTS AT YOUR SERVICE

The Supersharpy not only produces a concentrated, dense, well-structured light beam, but it also generates perfectly even colored light. This is achieved using a new optical unit with a 170mm (6.69") diameter outer lens. The beam that emerges from it is very similar to a searchlight beam. Its diameter may be altered using a set of beam diameter reducers, which produce light beams with different beam angles (from 0° to 4°) and thicknesses, including a "surgical" micro-beam, similar to a laser beam. The brightness remains the same at all beam angles and the minimum angle is literally zero degrees. This means the Supersharpy's beam is perfectly parallel for its entire length. The Supersharpy is fitted with a CMY color mixing system, with three gradual-insertion wheels. In addition it features fixed colors, which may be selected and overlapped to produce a nearly infinite variety of shades and

tones. It also has two filters (3200 K and 2500 K). The beam edges may be softened with a frost filter system, to such an extent you can almost transform the Supersharpy into a washlight. The Supersharpy has two gobo wheels. The first has 7 high-definition dichroic rotating gobos. The second has up to 18 fixed metal gobos, including a large selection of beam diameter reducers. The gobos can be used primarily to shape the light beam in midair, but - thanks to the Supersharpy's extraordinary optical unit - they can also project perfectly focused images onto surfaces even hundreds of yards away. Its incredible brightness, compact size, reliability and speed, together with the smoothness of its movements and the wealth and quality of its effects, make the Supersharpy the benchmark ACL beam moving light for top productions.



### SUPERSHARPY - Photometric Diagram

Standard (2.6°) - Total Output: 23800 lumens

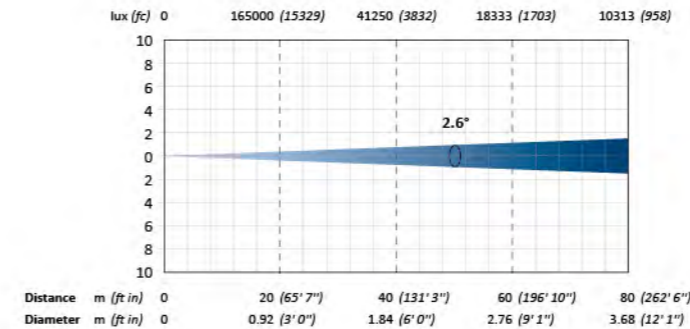

Light Source	MSD Platinum 20R
Power Consumption	470 W
Color Temperature	7,800 K
Luminous Flux	23,000 lumen
Nominal Life	1,500 h
Socket	Faston TM 250 (6.35 mm)



Paris New Year's Eve // Photo: Henri Garat



Super Bowl XLIX Halftime Show



Schuman Bridge, Lyon // Photo: tetro.fr - Andrea Aubert

### Fixed Gobo Wheel



### Color Wheels and CMY System

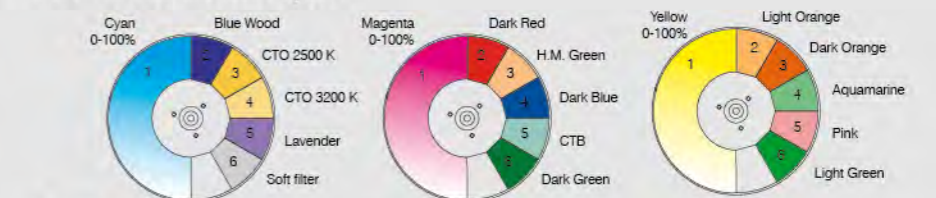

### Rotating Gobos

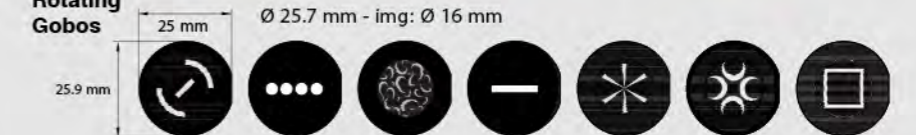



## ACCESSORIES

MSD PLATINUM 20R (7,800 K) PHILIPS LAMP (standard)	code LAM00F
OMEGA for fixing clamps (standard)	code 183102/805
CLAMPS hooks for truss Ø 48-51mm max 300 Kg (optional)	code C21070
SAFETY CABLE Ø 4mm, lenght 680mm (optional)	code 105041/003
FOAM SHELL (optional)	code F21262

## ROXTER-CASE (OPTIONAL)



ROXTER-CASE  
(including 2 foam shells)  
for 2 Supersharpy/Mythos  
code F21263

## OUTDOOR ENCLOSURES



IGLOO  
with Wireless DMX receiver/transmitter  
code C61199

IGLOO EASY  
Easy version with no W-DMX  
code C61197

IGLOO ECO  
code C61196

## WEIGHT AND DIMENSIONS (mm/inches)

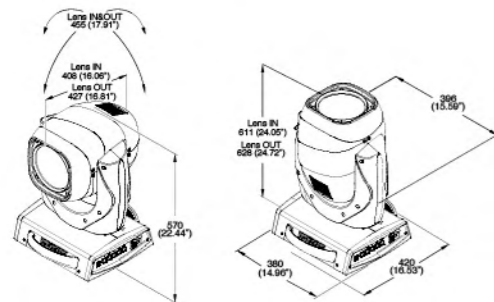

Mythos  32 kg (70.54 lbs)  
Supersharpy  31 kg (68 lbs)

## CERTIFICATIONS



Standard for Safety for Stage and Studio  
Luminaires and Connector Strips  
UL 1573 Fourth Edition

Standard for Stage and Studio Luminaires,  
CSA C22.2 No. 166-M1983

## PAN/TILT

MYTHOS		SUPERSHARPY	
PAN Rotation	540°	PAN Rotation	540°
PAN Speed	3.517 sec	PAN Speed	3.301 sec
TILT Rotation	244°	TILT Rotation	244°
TILT Fast speed	2.180 sec	TILT Fast speed	2.060 sec

## DMX 512 CHANNELS

MYTHOS		SUPERSHARPY	
1	Cyan	1	Cyan
2	Magenta	2	Magenta
3	Yellow	3	Yellow
4	Color Wheel 1	4	Color Wheel 1
5	Color Wheel 2	5	Color Wheel 2
6	Color Wheel 3	6	Color Wheel 3
7	Stop / Strobe	7	Stop / Strobe
8	Dimmer	8	Dimmer
9	Fine Dimmer	9	Fine Dimmer
10	Fixed Gobo Change	10	Fixed Gobo Change
11	Animation Disc Insertion	11	Rotating Gobo Change
12	Animation Disc Rotation	12	Gobo Rotation
13	Rotating Gobo Change	13	Fine Gobo Rotation
14	Gobo Rotation	14	Prism Insertion
15	Fine Gobo Rotation	15	Prism Rotation
16	Prism Insertion	16	Frost
17	Prism Rotation	17	Focus
18	Frost	18	Pan
19	Zoom	19	Fine Pan
20	Focus	20	Tilt
21	Fine Focus	21	Fine Tilt
22	Beam Mode	22	Function
23	Pan	23	Reset
24	Fine Pan	24	Lamp Control
25	Tilt	25	Pan-Tilt Time (vector mode)
26	Fine Tilt	26	Color Time (vector mode)
27	Function	27	Beam Time (vector mode)
28	Reset	28	Gobo Time (vector mode)
29	Lamp Control		
30	Macro Effects		
31	Pan-Tilt Time (vector mode)		
32	Color Time (vector mode)		
33	Beam Time (vector mode)		
34	Gobo Time (Vector Mode)		



# MYTHOS

IS ALREADY LEGEND







WWW.THEPROJECTORS.IT



MYTHOS AND SUPERSHARPY on

YouTube



AN OSRAM BUSINESS

CLAY PAKY S.p.A. - I - 24068 Seriate (BG) - Via Pastrengo, 3/b  
Phone +39 035 654311 - Fax +39 035 301876 - www.claypaky.it - info@claypaky.it



UNI EN ISO 9001