

# NEW PRODUCTS

# 2018

ENGLISH

**ADB STAGELIGHT**   
AN OSRAM BUSINESS

[www.adbstagelight.com](http://www.adbstagelight.com)

# INDEX

LEXPERT FAMILY.....	3
LEXPERT PROFILE L.....	4
LEXPERTFRESNELM.....	6
LEXPERT EMPHASY.....	8
KLEMANTIS.....	10
OKSALIS.....	12
IMAGO & IMAGO WING.....	14
HATHOR 2.0.....	16

# LEXPXPERT FAMILY

The LEXPERT family is a range of LED light projectors featuring advanced digital technology and extremely high quality light. LEXPERTs are designed for those who appreciate the advan-

tages of LEDs, but still prefer white light sources: a step towards the future, but with respect for the ways of those who have to use them.

LEXPERT is guaranteed by Osram's

long experience in the lighting industry, and jointly designed by ADB's R&D department. It provides all the benefits of high quality LED luminaires, with excellent value for money.





# LEXP PERT PROFILE L

## 300 WATT WHITE LED PROFILE SPOTLIGHT DESIGNED TO REPLACE 1 KW HALOGEN PROFILE UNITS

The LEXPERT PROFILE is a white LED light able to produce a powerful, high quality light beam. The two versions available in the catalogue have different color temperatures: warm (3200K) or daylight (5600K). They are built to be modular: the body

containing the LED source works together with an optical unit with either a 15°-30° or a 25°-50° zoom. The two zoom modules are perfectly interchangeable with each other. The Lexpert Profile is equipped with a very versatile dimming system. You can

choose between 8 and 16 bit operation on five channels modes, with four preset dimmer curves. Alternatively intensity can be manually adjusted using an easily accessible knob on the back of the unit. The shaping system consists of four

### WEIGHT AND DIMENSIONS

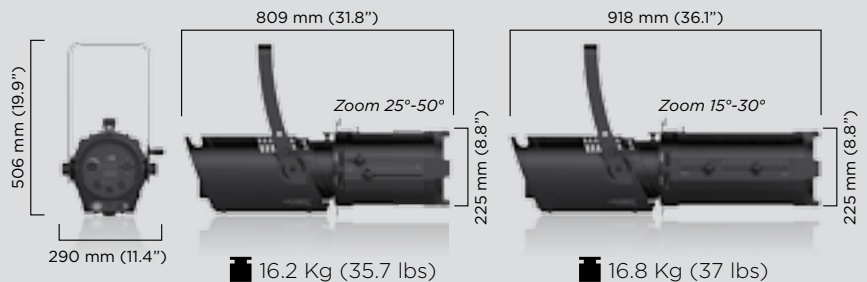

plates, which shape the light beam precisely. The unit also houses a gel holder for inserting color or frost filters, and a pattern holder, or an optional

18-blade iris.

The frequency of this very silent light may be set to between 600 and 4800 Hz and you may choose either

DMX512, RDM or ArtNet3 control. The Lexpert Profile is the ideal unit for lighting theatres, TV studios and multi-functional venues.

## MAIN FEATURES

- Excellent smooth light output
- Interchangeable optical unit
- Two color temperatures: warm white (3200K) or daylight (5600K)
- Powerful, high-quality beam (high CRI)
- Beam shaping system and gobo holder
- Extremely smooth 16-bit dimming
- Strobe effect and gradients effect
- Excellent thermal design
- 4 fan selection: boost, standard, silent, ultra-silent
- Noise: 30 dB @ 1m in standard mode; under 25dB @ 1m in silent mode

## LIGHT SOURCE

- 280W White LEDs

## OPTICAL

- Zoom option: 15°-30° or 25°-50° (interchangeable)
- CRI: WW $\geq$ 90; CW $\geq$ 85

## CONTROL

- DMX channels: 1/2/3/4/5, depending on the mode
- Control mode: DMX512, RDM, ArtNet
- Dimming adjustable manually via a rotating button
- Firmware upgrade: update via webpage with RJ45 socket

## ELECTRICAL

- Power voltage: AC 100-240V, 50/60Hz
- Power consumption: 382 W
- Protection rating: IP20

## PHOTOMETRY

Beam	3200K (Warm White)
15°	6423 lux @ 4m (standard mode)
30°	2278 lux @ 4m (standard mode)
25°	2482 lux @ 4m (standard mode)
50°	911 lux @ 4m (standard mode)

Beam	5600K (Daylight)
15°	8452 lux @ 4m (standard mode)
30°	3116 lux @ 4m (standard mode)
25°	3976 lux @ 4m (standard mode)
50°	1209 lux @ 4m (standard mode)

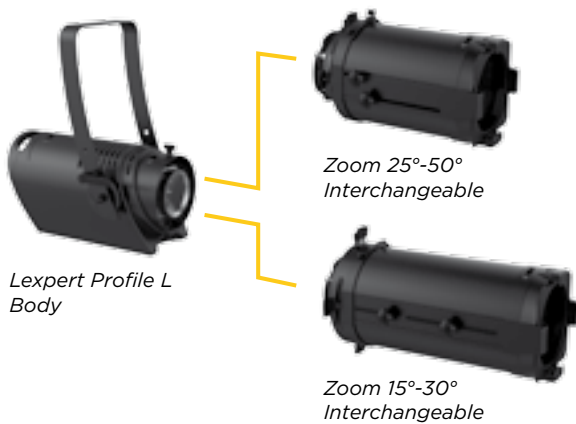

LCD Display

RJ45 socket IN Neutrik

Data IN/OUT: XRL 5 pins Neutrik

Power IN/OUT: Neutrik PowerCon

April 2018

Subject to change without notification

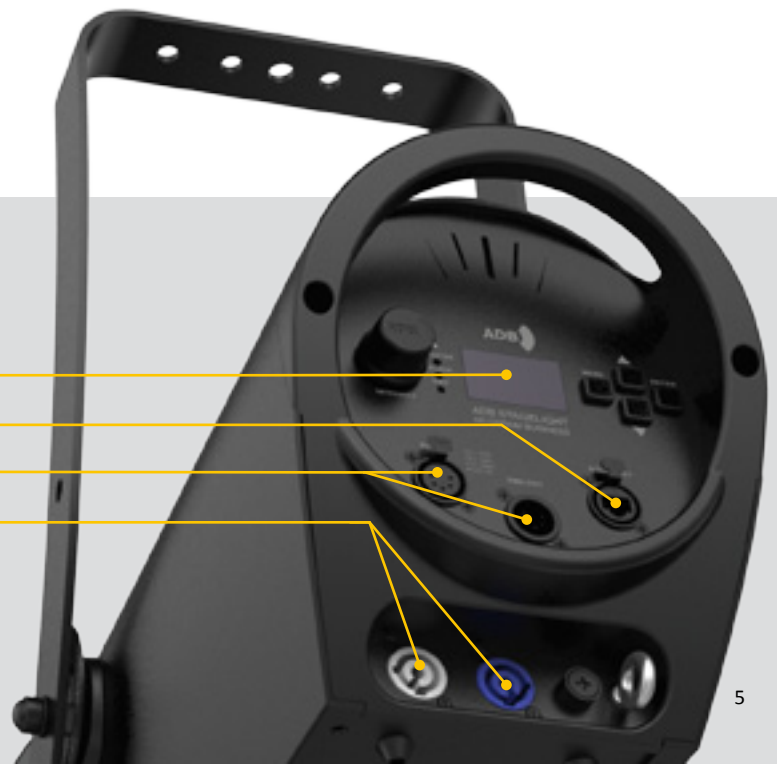



# LEXPERT FRESNEL M

## 150 WATT WHITE LED UNIT DESIGNED TO REPLACE 1 KW HALOGEN FRESNEL LIGHTS

The compact, lightweight LEXPERT FRESNEL M, with excellent heat dissipation and noise level of less than 30 dB, provides a powerful, smooth white LED light. Thanks to its 200 mm (nearly 8") high quality Fresnel lens

and motor-driven linear zoom, the Lexpert Fresnel M provides a uniform beam, which can be adjusted from 8 to 80 degrees using local and DMX controls.

It is equipped with a very versatile

dimming system: you can choose between 8 and 16-bit operation on four channels, with four preset dimmer curves. Alternatively it can be manually adjusted using an easily accessible knob on the back of the unit.



### WEIGHT AND DIMENSIONS

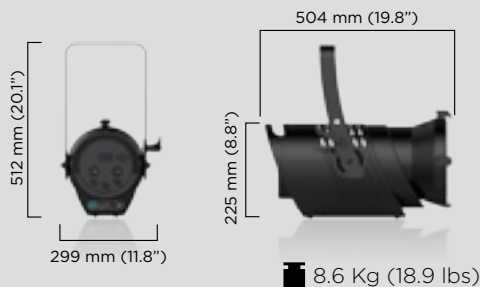

The fixture can be ordered in two different color temperatures - warm (3200K) or daylight (5600K) - and features a gel frame and optional

rotating barndoors.

With a frequency selectable from 600 to 4800 Hz, and DMX512, RDM and ArtNet3 control to choose from, the

Lexpert Fresnel M is ideal for lighting theatres, TV studios, multi-purpose rooms and other venues.

## MAIN FEATURES

- Excellent smooth light output
- High-quality light beam
- Excellent thermal design
- Two color temperatures: warm white (3200K) or daylight (5600K)
- Extremely wide 8°-80° linear motorized zoom
- Linear dimming (8/16 bit)
- Selectable frequencies: 600, 1200, 1800, 2400, 3000, 3600, 4200, 4800 Hz
- Strobe effect and gradients effect
- Optional rotating barndoors and hanger
- 4 fan selection: boost, standard, silent, ultra-silent
- Low noise: under 30 dB @ 1m

## OPTICAL

- 200 mm high quality fresnel lens
- 100% Linear motorized zoom (8/16 bit)
- Beam angle: 8° - 80°
- CRI: WW≥94; CW≥90

## LIGHT SOURCE

- 300W White LEDs

## CONTROL

- DMX channels: 1/2/3/4/5, depending on the mode
- Control mode: DMX512, RDM, ArtNet3
- Dimming adjustable manually via a rotating button
- Zoom adjustable manually via a rotating button
- Firmware upgrade: update via webpage with RJ45 socket

## ELECTRICAL

- Power voltage: AC 100-240V, 50/60Hz
- Power consumption: 382 W
- Protection rating: IP20

## PHOTOMETRY

Beam	3200K (Warm White)
narrow	3790 lux @ 4m (standard mode)
wide	260 lux @ 4m (standard mode)
Beam	5600K (Daylight)
narrow	4466 lux @ 4m (standard mode)
wide	282 lux @ 4m (standard mode)

LCD Display

Data IN/OUT: XRL 5 pins Neutrik

RJ45 socket IN Neutrik

Power IN/OUT: Neutrik PowerCon



April 2018

Subject to change without notification



# LEXP EMPHASY

STYLISH, COMPACT YET VERY BRIGHT, FOR HIGHLIGHTING PRECIOUS DETAILS AND ARCHITECTURAL FEATURES

EMPHASY is an LED profile spot for accent lighting with an elegant, compact, lightweight design. The unit has built-in electronic control, and is fan-less for total silence. It is the perfect solution for all applications where the fixture cannot be hidden and an object or an architectural detail has to be enhanced; for instance in museums,

art galleries, shop-windows, exhibition stands, restaurants, hotel lobbies, churches and other commercial and entertainment venues.

EMPHASY features a high color rendering index (CRI≥95), stable over time, and a very high light output for its power consumption. The lens designed around the LED



## WEIGHT AND DIMENSIONS

**EMPHASY** ■ 1.8 Kg (3.9 lbs)

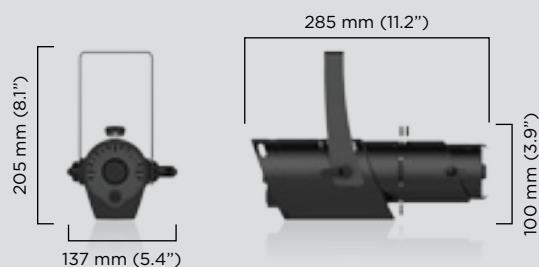

**EMPHASY DMX (available on request)** ■ 2.2 Kg (4.8 lbs)

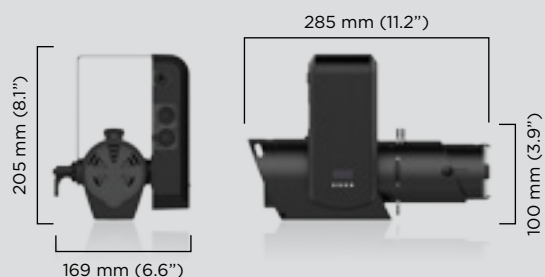



delivers a precise, sharp, perfectly diffused beam. The unit is available in various versions, with different beam angles (19°, 26°, 36° or 50°), color temperatures (3200K or

5600K), body finishing color (black or white). A DMX version for theatrical use is available.

EMPHASY is guaranteed by Osram's long experience in the lighting

industry and it has been jointly designed by ADB and Claypaky's R&D departments. It provides all the benefits of LEDs with excellent value for money.

## MAIN FEATURES

- Stylish design, sturdy, compact and lightweight
- Built-in electronic control
- Excellent thermal design without fans
- Enhanced optical design for a precise and uniform beam projection
- Powerful light output with a CRI<sub>a</sub>95
- Beam shaping system and gobo holder (included)
- Selection of 4 beam angles: 19°, 26°, 36° or 50°
- Available in 3200K or 5600K color temperature
- 0-100% smooth and precise dimming control
- Optional remote control via DMX signal available on request
- Accessories: filter frame holder, clamp, safety cable
- Adaptable to most common track lighting connectors (connector is not supplied)
- Available in black or white
- ETL & CE compliant

## LIGHT SOURCE

- 36W high powerful LED
- High-quality, high-contrast lenses
- Perfect beam edge at any distance

## CONTROL

- Dimming controlled via a rotating button or via DMX (optional)
- Firmware upgrade via DMX link (only DMX version)
- Data IN/OUT: XLR 5 pins Neutrik (only DMX version)

## ELECTRICAL

### EMPHASY

- Power at full intensity: 28W
- Voltage: 120-277VAC 50-60 Hz mains input via power cord with bare wires

### EMPHASY DMX (available on request)

- Power at full intensity: 30W
- Voltage: 90-264VAC, 50/60 Hz mains input via power cord with bare wires

## PHOTOMETRY

Beam Angle	3200K
19°	390 lux @ 5m 1080 lux @ 3m
26°	222 lux @ 5m 616 lux @ 3m
36°	142 lux @ 5m 395 lux @ 3m
50°	76 lux @ 5m 210 lux @ 3m

Beam Angle	5600K
19°	436 lux @ 5m 1211 lux @ 3m
26°	244 lux @ 5m 678 lux @ 3m
36°	160 lux @ 5m 444 lux @ 3m
50°	88 lux @ 5m 244 lux @ 3m



Enhanced optical design



Dedicated slot for filter frame



Beam shaping system and dedicated slot for gobo holder



Dimming controlled via a rotating knob

April 2018

Subject to change without notification

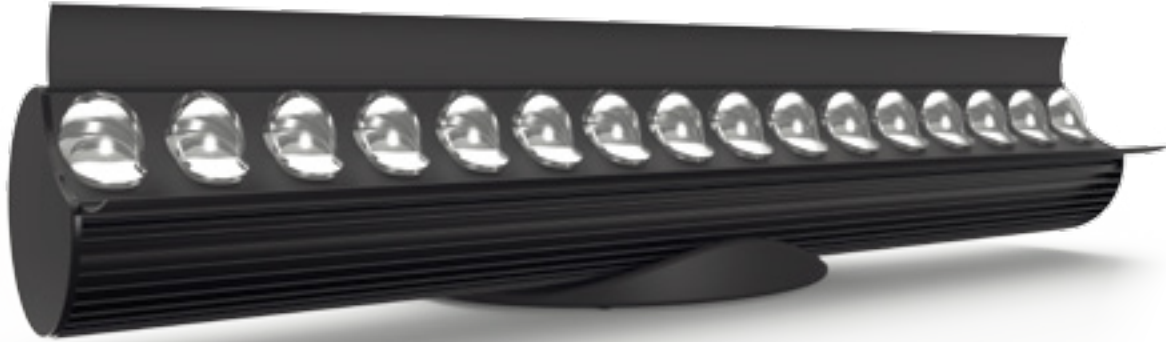

## KLEMANTIS

### THE NEW CYCLIGHT BY ADB, WITH STATE-OF-THE-ART LED TECHNOLOGY

The new ADB KLEMANTIS is an asymmetric cyclight based on a six-color LED module, which uses cutting-edge HCR (high color rendering) LED technology to deliver a wide selection of colors from bold hues to pastel shades.

Thanks to an innovative algorithm, the unit is capable of achieving a stable CRI of over 97, as well as an impressive tunable white light ranging from 2500K to 8000K

Its light output is enhanced by an innovative optical system, which enables the Klemantis to generate a uniform light with excellent diffusion and perfectly blended colors.

The KLEMANTIS units form a family of fixtures which are designed to be used in linear arrays. The KLEMAN-

TIS AS1000 is fitted with 16 multi-source LED modules and the KLEMANTIS AS500 with 8.

They can be used horizontally, vertically, laid on the floor, or hung from above on a bar. The AS500 is particularly suited for lighting cyc corners.

Unlike any other product on the market, the KLEMANTIS can be installed up to 60 cm from the cyclorama.

The Klemantis is a creative tool designed to meet today's lighting design needs. Its unique features and the unit's design reinvent the cyclorama concept, making it the perfect choice for any professional application.

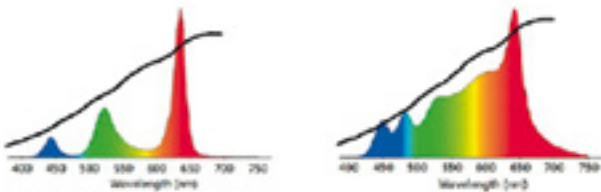
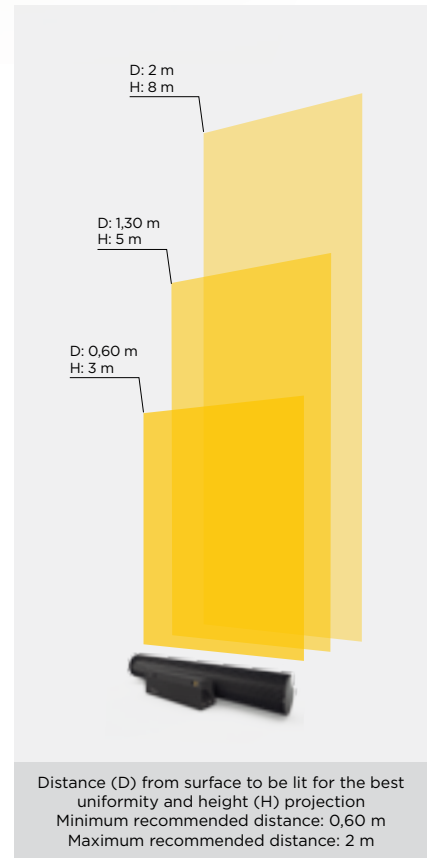

RGB(W) vs. 6-COLORS: AMBER, CYAN and LIME have been singled out as the perfect colors to complement the gaps in wavelength found in typical RGB systems.

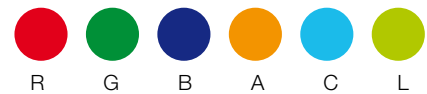

PROPRIETARY 6-COLOR LED SOURCE:  
 R+G+B+Amber+Cyan+Lime  
 The six-color chip guarantees the highest CRI and a broader coverage of the Color Gamut

## SPECIFICATIONS

- Beam type: asymmetric flood
- Very high CRI, >97 throughout the entire CCT (up to 99)
- Tunable white ranging from 2500K to 8000K, with perfect CCT
- Tungsten mode, to replicate the behaviour of a tungsten lamp during dimming from 0 to 100% and vice versa, including color temperature adjustment
- Tint correction: +/- green/magenta adjustments
- 16-bit ultra-smooth dimming, with different dimming curves available
- Exclusive LED module featuring six colors: red, green, blue, cyan, lime and amber
- Wide color gamut and extended spectrum, including deep blue and deep red
- Smooth color transition through different times, cross-fade and path options, and a gamma correction system
- Color control: hue saturation luminosity (HSL), CMY, RGB and RAW modes fully exploit the potential of the six-color system; wide selection of Digital filters (Color macros) which reproduce the spectrum of gel filters with tungsten bulbs
- High color stability and accuracy, also in tungsten mode, thanks to a high resolution driver
- Color consistency over time and temperature changes, thanks to combined fixture calibration and a LED ageing compensation algorithm
- Fixture to fixture color repeatability, thanks to tight wavelength binning selection and 100% fixture calibration
- Power supply: 100-240 V, 50/60 Hz
- Max power consumption: 250W
- Inputs: PowerCon IN, DMX 5 poles, USB Ethernet
- Outputs: PowerCon OUT, DMX 5 poles
- Daisy chain via PowerCon cable, max 5 KLEMANTIS AS 1000
- Connections IN and OUT for daisy chain, max 5 units
- Control protocols: DMX512, RDM, ArtNet, sACN
- Flicker-free, thanks to PWM frequency adjustment from 1 KHz to 50 KHz (10 Hz steps)
- LED cooling by natural convection

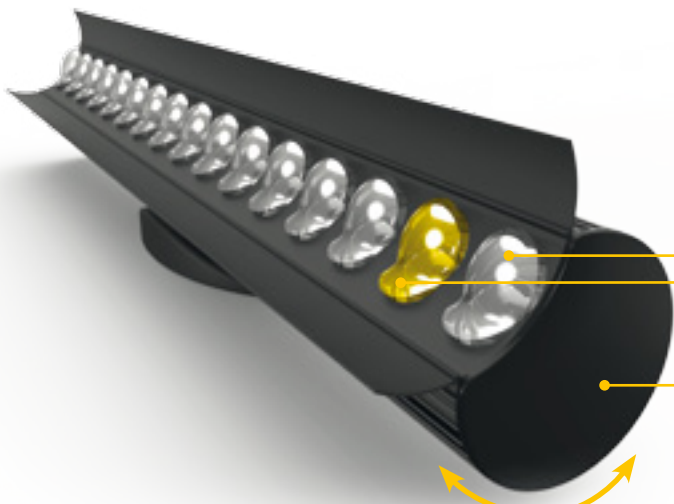

*The fixture can be tilted on its base*

## DIMENSIONS

KLEMANTIS AS1000

LxWxH (mm): 1000 x 271 x 196

LxWxH (inches): 39.4 x 10.7 x 7.7

KLEMANTIS AS500

LxWxH (mm): 500 x 271 x 196

LxWxH (inches): 19.7 x 10.7 x 7.7

## OPTICAL SYSTEM

Special optical mixing chambers with reflective internal walls ("rods") convey the light output from each LED to the lens: this system generates perfectly mixed and uniform colors, without shadows or multi-colors at the output.

Enhanced ASYMMETRICAL LENSES for cyclorama lighting provide uniformity > 90% regardless of the cyclorama height.

## TUNGSTEN MODE

It's a special function which emulates the tungsten lamps: every parameter is set to emulate the performance of an incandescent bulb, specifically the dimming curve and the related color shift. Five different digital tungsten lamps are available.

## COLOR MANAGEMENT

Klemantis features 4 operating modes: Raw Mode, HSL, RGB emulation and CMY emulation.

HSL mode is an innovative function allowing to manage both colors and white light, based on a complex, exclusive algorithm. In this mode, the CRI is kept constantly > 97, irrespective of color temperature.

## COLOR LIBRARIES BASED ON GEL FILTERS

DMX channel for finding the color required, from among a huge selection based on color gels commonly used in the theatre.



## OKSALIS

### THE LED FLOOD LIGHT FOR THEATRE PROVIDING TOTAL CONTROL OVER WHITE AND COLORED LIGHT

OKSALIS is a LED washlight which provides total control over the quality of all forms of white or colored light. The new HighColorRendering technology used in the OKSALIS is an exclusive electronic platform developed by Osram for ADB, to meet the needs of lighting designers who were not fully satisfied with the performance of LED devices in comparison with traditional lamps.

The heart of the Oksalis washlight is a LED light module consisting of six chips, each for a different color: besides the three “classic” basic

Red, Green and Blue colors, ADB added Amber, Cyan and Lime. This exclusive device provides a very wide color range with extraordinary color spectrum coverage.

Along side the LED-light-source heart of this system is its brain: the brand new sophisticated software algorithm that controls its functions. The light produced by the OKSALIS has a CRI that reaches values that have never been achieved before by LEDs: the typical CRI value is 97, up to 99. These values were previously only possible with traditional technology.

The light parameters are managed through different DMX modes and channels, six of which are dedicated to specific colors and another six are used for fine tuning: once a color has been selected, you can enrich the palette with an infinite number of shades. There are also two additional independent channels: one for linear color temperature adjustment from 2500K to 8000K, and another devoted to a wide selection of macros that make programming easy.

The OKSALIS fits an extremely high quality optical unit, with

proprietary lenses that guarantee even light diffusion and eliminate stray reflections. The zoom ranges from 6° to 50°, with uniform light diffusion at any beam angle. A 16-bit resolution electronic dimmer means you can adjust light intensity in indiscernible infinitesimal steps. Different dimmer curves are available so you can adapt it to all stage requirements. The fixture may be controlled via DMX, RDM Protocol, Web Server or ArtNet. The OKSALIS has a perfectly

homogeneous lumen output, thanks to a source calibration and color balancing procedure which is carried out on every single light during the production testing stage. Furthermore, the control algorithm of each fixture compensates for drifts in color due to ageing on the basis of a model stored in the unit's memory that simulates ideal behaviour during its working life. These sophisticated features together ensure color consistency both between one light

and another, and over time.

Silent operation is a particular strong point: its heat sink is die-cast and has forced ventilation, which cools the unit with minimal noise.

The OKSALIS is suitable for use in all professional fields of application, where great brightness, a wide range of colors, and a high CRI are particularly appreciated. In fact, the OKSALIS can be used in theatres, television studios, showrooms and exhibitions.

## MAIN FEATURES

- State-of-the-art LED moving head washlight
- Power consumption: 500VA (FL20), 300VA (FL10)
- Light sources: 32 LED modules (FL20), 17 LED modules (FL10)
- 6-color LED module: RGB + Amber + Cyan + Lime
- Rated LED module average lifetime: 50,000h
- Total lumen output: 8500 lumen (FL20); 4250 lumen (FL10)
- Typical CRI value: 97, up to 99
- 2500K-8000K color temperature correction
- Color control: RAW mode, HSL mode, RGB mode, CMY mode
- Dedicated color macro channel
- Software algorithm by Osram
- 6°- 50° linear zoom
- Electronic linear dimmer, 16 bit
- Optional frame for external gels and frost filters
- Optional top hat
- Protocols/Functions: DMX, RDM, Web Server and ArtNet
- Totally flicker free



## WEIGHT & DIMENSIONS

OKSALIS FL20

17 Kg (37.48 lbs)

mm (LxWxH): 479 x 300 x 474

inches (LxWxH): 18.86 x 11.81 x 18.66

OKSALIS FL10

12 Kg (26.45 lbs)

mm (LxWxH): 357 x 300 x 461

inches (LxWxH): 14.06 x 11.81 x 18.15

April 2018

Subject to change without notification

# IMAGO & IMAGO WING

## A SOPHISTICATED FLEXIBLE CONTROL SYSTEM, ALWAYS TO HAND

Imago and Imago Wing are flexible, professional tools for modern programming. They are compact, light-weight, ergonomic, sophisticated, universal lighting control desks, always at hand, which can be easily carried around in a backpack.

IMAGO is based on a keypad, a sequential crossfade, six Subfaders and six Executor keys with illuminated keys. Because moving lights are central to most of today's

productions, IMAGO comes with four push wheels and dedicated keys, allowing operators to efficiently control fixture parameters. The IMAGO WING completes the IMAGO family offering, when associated to the IMAGO, additional control possibilities (18 Subfaders and 18 Executor keys).

The system works with Hathor software via a USB connection to a PC, with 16,384 parameters via Ethernet.

### IMAGO

6 EXECUTOR  
BUTTONS

4 ROTARY WHEELS  
WITH PUSHBUTTON  
FUNCTION

2 PHYSICAL 100mm  
SMOOTH FADERS

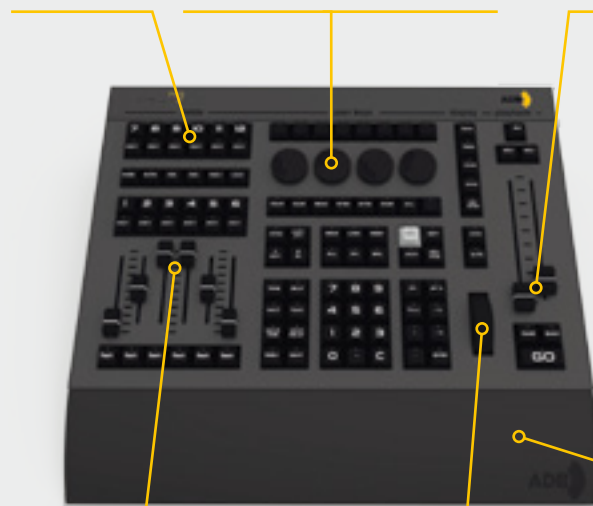

6 PHYSICAL  
SUBFADERS

1 INTENSITY / SPEED  
CONTROL WHEEL

### IMAGO WING

18 EXECUTOR  
BUTTONS

18 EXECUTOR  
SUBFADERS

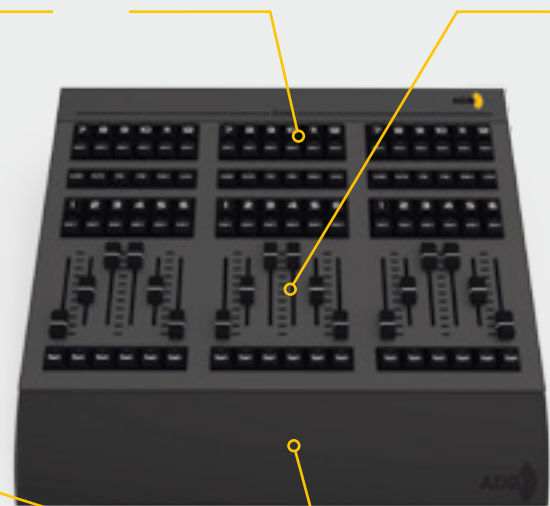

ERGONOMIC, REMOVABLE  
ARM REST

### A WIDE RANGE OF UNIVERSAL APPLICATIONS

The Imago system can be used as a complementary controller to all ADB Hathor based consoles or in all applications where you need a powerful main lighting controller. Its compact size and light weight make it ideal for lighting designers who are always on the move.

### KEY BACKLIGHTING

Thanks to the illuminated keys, all functions, as well as the keypad and the Subfader numbers are easily readable in the dark.

## IMAGO MAIN FEATURES

- 6 physical 60 mm Subfaders with Assign key, Start key and Flash button
- 6 Executor buttons (including Assign key and Start key)
- Loading possibilities: Channels, Groups, Presets, Looks, Chasers and Palettes
- 1 Sequential Theatrical Crossfade:
  - 2 physicals 100 mm smooth faders
  - GO / BACK / PAUSE / keys
- 1 Intensity / Speed control wheel
- 4 rotary Wheels with Pushbutton function
- 7 Attribute Group/Palette keys
- Virtually unlimited screen's user layouts
- COPY ATT key
- 8 Free assignable keys
- Channel selection: +, -, Thru, +%, -%, At Level, All and Invert commands

## IMAGO WING MAIN FEATURES

- 18 physical Subfaders 60 mm with assign key, Start key and Flash button
- 18 Executor buttons (Assign key and Start key)
- F/B -, F/B+, FB#, DSR, INHIBIT, Flash mode keys
- 6 Action List keys
- 6 Free assignable keys

## WEIGHT AND DIMENSIONS

### IMAGO

■ 4.6 Kg (10.14 lbs)

LxWxH (mm): 415 x 285 x 80

LxWxH (inches): 16.34 x 11.22 x 3.15

### IMAGO WING

■ 4.6 Kg (10.14 lbs)

LxWxH (mm): 415 x 285 x 80

LxWxH (inches): 16.34 x 11.22 x 3.15

- Direct Numeric entry for SEQUENCE Times and Special Times
- RECORD/UPDATE for Presets, Looks, Groups, Palettes with filtered options
- EDIT key
- FETCH key

### CONNECTIONS

- DMX Out: 2 DMX512 XLR 5 pins female
- DMX In: 1 DMX512 XLR5 pin male
- 2 USB Ports A
- 1 USB Port B
- 1 Desk Lamp supply

### POWER REQUIREMENTS

- External Power supply 12 V 700 mA

### CONNECTIONS

- 1 USB Port B
- 1 Desk Lamp supply
- 1 DC output 12 V 700 mA

### POWER REQUIREMENTS

- External Power supply 12 V 700 mA

## HATHOR SOFTWARE MAIN FEATURES

- 32 Universes: 16,384 outputs / parameters via Ethernet
- Available Control Protocols: ARTNET, sACN, Sandnet, Pathport, Shownet
- 192 virtual Submasters (assignable in banks to physical faders) & 1000 Submasters pages
- 24 Playbacks & 1000 Sequences ("Cuelists")
- Tracking mode for parameters, including automatic Move In Black, as well as CUE only mode in a very intuitive way

## THE IMAGO SYSTEM





## HATHOR SOFTWARE

### THE SOPHISTICATED LIGHTING SOFTWARE FOR PASSIONATE PEOPLE

Designed with theatres in mind, HATHOR offers a user friendly and comfortable programming environment: an optimized Channel Grid displays all essential information at a glance - Impressive multi-users (Master - Backup - Clients) net-

worked architecture - A unique drag'n drop function along with right-click contextual menus make HATHOR fast, simple and intuitive to use - A free, fully functional version is available with restricted DMX outputs - An unequalled browser-

based import system allows for a comprehensive item preview before importation - Thanks to an advanced track window with extensive overview of recorded intensities and moving light parameters, immediate editing is made possible.

#### HATHOR SOFTWARE 2.0 **NEW RELEASE**

Starting from March 2018, ADB has released version 2.0, featuring these main new features:

- Over 10,000 templates with bi-weekly updates independent from software updates
- Fixed faders in submasters, not included in page management, like Playbacks with IN & OUT
- Grand Master, Independents, and Fields
- Innovative HSI colors handled by Color Picker
- Exclusive Park Function, by Device or by Parameter
- Mobile solution available. **Wily for Hathor** is the Smart lighting application for the Hathor product range. Much more than a remote control, the App\* enhances your Ipad and Iphone into freely configurable smart consoles

*\*Optional software. System requirements: iOS10 or later versions*

Release 2.0 of Hathor software can be found on the new ADB Stagelight website ([www.adbstagelight.com](http://www.adbstagelight.com)), both on the page devoted to Hathor and on the download page.







# Eurodim twintech

**DON'T LIMIT YOUR INVESTMENT TO ONLY 96 CHANNELS!**

- Up to 128 three-kilowatt channels.
- Designed for professional applications in theatres, concert halls and TV studios.
- More load per cabinet than any other dimmer on the market (3 kW configuration).
- The only one capable of operating either as a dimmer (0-100%) or as a static relay (ON-OFF switch), while protecting the components and ensuring the maximum lifespan of the connected equipment.
- Full control of all dimmer functions through a user friendly touchscreen interface.
- Automatic load balancing between all three phases.
- Three cooling fans to protect your lighting show.
- Premium quality and technical support guaranteed by ADB, part of the Osram/Claypaky group.

**EURODIM TWINTECH: YOUR BEST INVESTMENT FOR THE FUTURE.**

**MAIN ADB REFERENCES:**

Opéra Bastille (France), Bolshoi Theatre (Russia, Moscow), Mariinsky Theatre (Russia, Saint Petersburg), Teatro Alla Scala (Italy), Beijing National Grand Theatre (China), renowned TV Studios and many more....



**THE POWER OF 384 kW IN YOUR HAND**

**REMOTE CONTROL FOR TWINTECH DIMMER**

Download the "RDM Dimmer Remote" App for iOS and Android



# ADB: ALMOST 100 YEARS DEVOTED TO THEATRE LIGHTING



ADB, founded in 1920, was one of the pioneers of modern stage lighting. Its products are known and appreciated throughout the world for their construction quality, reliability and excellent performance, especially in the fields of theatre and television.

Since August 2016, ADB has become part of the Osram Group and merged its business with Claypaky, known for its multifunctional fixtures and unparalleled capacity for innovation.

ADB and Claypaky together set a benchmark today in the field of professional show lighting, owing to their unique capability of offering complete, integrated solutions for any kind of projects from television studios to theatres of all sizes, with a range of products including dimmers, control systems, static and moving luminaires featuring halogen, discharge and LED sources and all sorts of accessories.

ADB and Claypaky together are able to provide their international clientèle with a widespread organization capable of offering expert support in the design of lighting systems, their installation and commissioning. Above all they offer private customers and public institutions an unparalleled technical support, with a guarantee that only a parent company like Osram can offer.

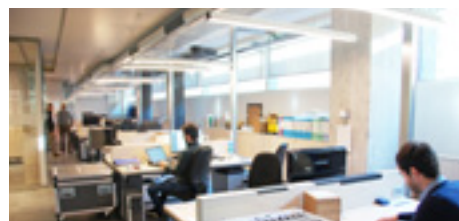

## PRODUCTS



## NEWS



## OLDIES BUT GOLDIES

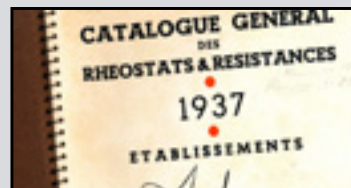

*more on [www.adbstagelight.com](http://www.adbstagelight.com)*



VISIT THE NEW ADB WEBSITE!

[www.adbstagelight.com](http://www.adbstagelight.com)

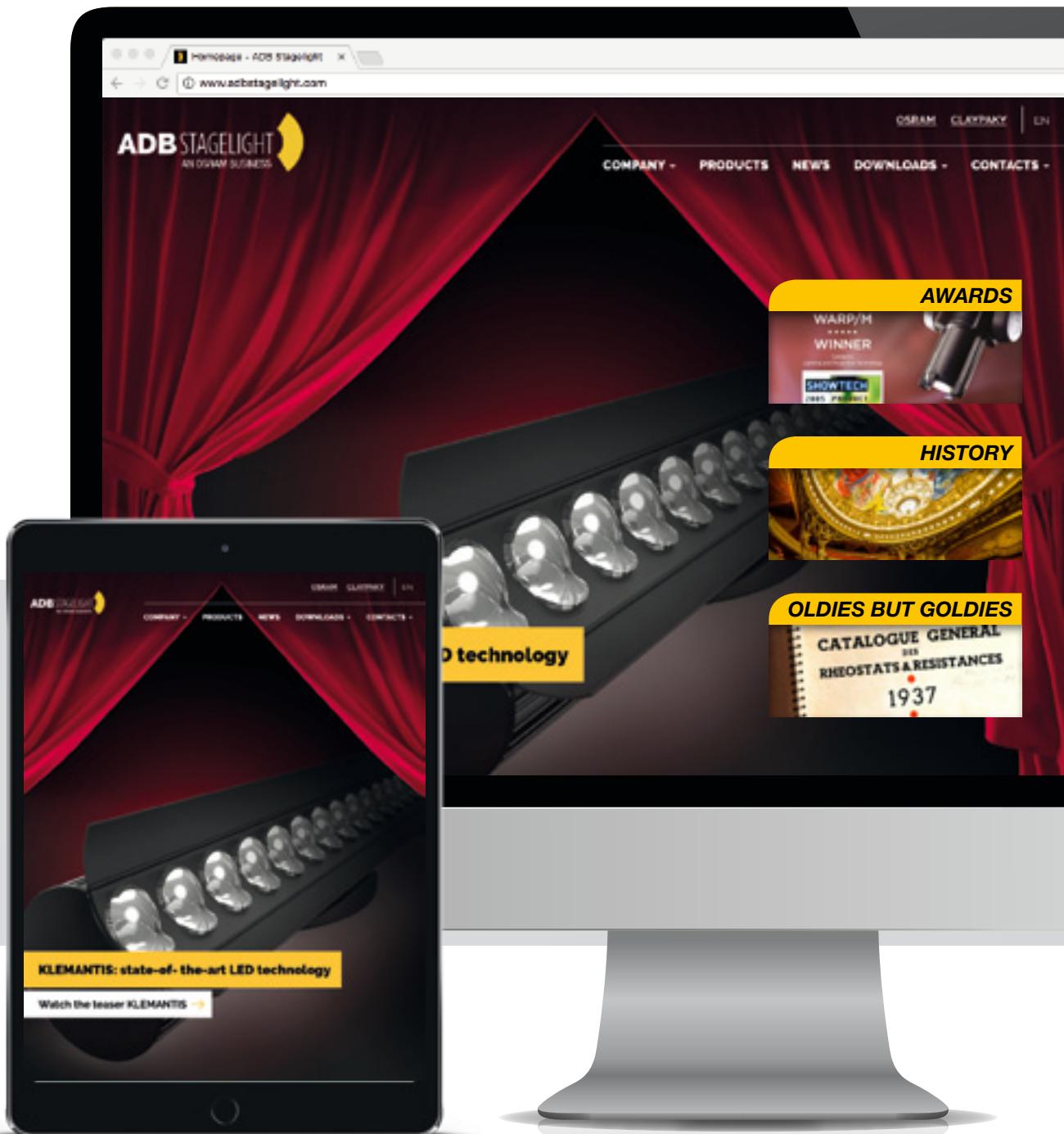



Headquarters & International Sales  
Via Pastrengo, 3/b - I-24068 Seriate (BG), Italy  
T +39.035.65.43.11 - F +39.035.30.18.76  
[www.adbstagelight.com](http://www.adbstagelight.com) - [info@adblighting.com](mailto:info@adblighting.com)

Factory and Logistics  
Zone Industrielle Rouvroy - F-02100 Saint-Quentin, France  
T +33.(0)3.23.06.35.70 - F +33.(0)3.23.67.66.56