

# CHARLES - 961SX

960SX - LED 600W



- **Type:** Profile spot
- **Source:** LED 600W
- **Optics:** 8° to 16° zoom
- **Colour temperature:** Cool White

Profile spot

## The bright new classic in LED profile technology with mighty output

Sharing its technology, output and quality of light with Oz and Alice, Robert Juliat presents its brilliant range of LED profiles, the Charles 960SX series. This range of 600W LED profiles is available in 3 variable zoom ranges and exhibits a high optical efficiency with a 6000K colour temperature and a CRI in excess of 90. Smooth electronic dimming and an in-built, flicker-free power supply gives silent operation and packs a high output that reaches 80% of the renowned 2.5 kW HID D'Artagnan capabilities.

### Features

- **Multi-function double gate:** simultaneous use of gobos and iris. Sharp focus of both gobo and shutter
- **Shutter gate:** up to 8 shutters. Remove shutters for easy maintenance or tuck fully inside gate for secure transport
- **User-friendly shutter-lock system:** secures shutters' setting in any circumstances (locking efficient up to 4 shutters)
- **Universal gobo holder:** "A" size glass and metal gobo
- **Gate lock feature:** secures rotating gate against unwanted movement
- **90° rotating gate :** rotation of the projected image is always possible – no need to move the yoke
- **Internal glass filter holder:** long term use of durable coloured, dichroic or textured glass
- **XLR7 connector:** for fan cooled front extension cassette (recommended for dark colours)
- **Adjustable response time:** choice of fast or slow dimming for tungsten-like simulation - adjustment by DMX protocol
- **Universal data control:** compatible with DMX, RDM, Art-Net, sACN protocols
- **Easy setup:** locally and remotely by RDM protocol - integrated display
- **DMX:** 8 or 16 bits dimming and strobe function
- **Parameters:** adjustable curves and response thru 4-button display with automatic light switch-off
- **Control:** local and DMX
- **Dimming parameters:** choice of square or linear dimming curves
- **Easy focus reference:** graduated scale on side of lantern; fast and easy refocusing
- **Tilt reference on hanging yoke:** index for rapid re-positioning

### Optical

- **Long life:** outstanding operational lifetime expectation, no need to replace lamps, low maintenance
- **Gobo :** excellent gobo projection
- **Variable zoom optics:** sharp focus at every beam angle. Independent control of image size and focus. Focus handles on both sides
- **Electronic dimmer:** dimming without clipping or cut-out at low intensity levels; high quality smoothing
- **No colour shift:** colour temperature remains the same when dimming

### Construction

- **Made in France :** fully manufactured in Robert Juliat premises retaining complete control over all aspects of quality
- **PSU:** built-in electronic flicker-free power supply for easy, plug-and-play installation
- **Power connectors:** neutriK® powerCON TRUE1 IN and OUT connectors for daisy chaining
- **Ethernet-DMX node:** data IN through RJ45 connector; data OUT through DMX for daisy chaining
- **Silent-running cooling fans:** ideal for TV studios and opera houses
- **Electronic thermal management system:** ensures maximum performance of the system without any risk of overheating
- **Bodywork:** strong sheet metal construction for durability
- **Moving parts:** smooth at all times, even when hot
- **Captive knobs and handles:** additional security when working at height or in transit
- **Spare parts and accessories:** uniform across the tungsten, discharge or LED range, reducing running costs
- **Easy access to all parts:** easy cleaning and maintenance

Picture:961SX

DSEN352\_961SX - 01/08/2019

Robert Juliat reserves the right to change or alter any of the items detailed on this page, to increase or improve manufacturing techniques without prior notice.

Robert Juliat S.A.S., 32 rue de Beaumont, 60530 Fresnoy-en-Thelle - France  
Telephone : +33 (0)3 44 26 51 89 - fax : +33 (0)3 44 26 90 79 - info@robertjuliat.fr  
www.robertjuliat.com



ROBERT JULIAT

## Source

- Lamp type: LED
- Power: 600 W

LED specifications	Power *	Lumen output*	Colour temperature*	Life*	CRI* (min)
LED 600W ( )	600 W	32 500 lm	6000K	20 000 h	91

(\*) manufacturer's data

## Optics

### Characteristics

- Type: Zoom
- Beam range: 8° to 16°
- Focal length: 285 - 572 mm

### Gel filter

- Shape: Square
- Standard size: 215x215 mm (8.5x8.5 in)
- Optional size: 245x245 mm (9.6x9.6 in)

### Gobo

- Size: A
- Material: Metal  
Glass



## Photometrics

with LED 600W ( ) source

### • Optics @ 8°

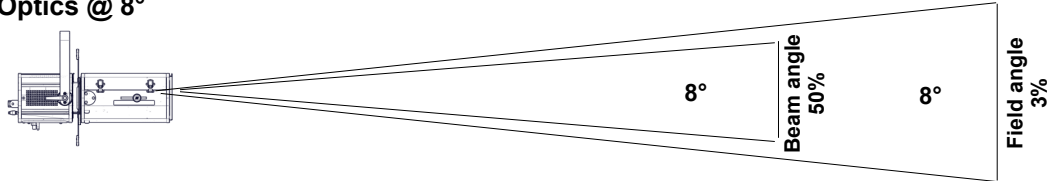

Beam intensity  
1 036 300 cd

Field lumens  
12 850 lm

Efficacy  
20 lm/W

CCT  
5 610 K

CRI  
90

Distance	10 m	20 m	30 m	40 m	50 m	60 m
Diameter	1.4 m	2.8 m	4.2 m	5.6 m	7 m	8.4 m
Illumination	10 500 lux	2 600 lux	1 200 lux	650 lux	420 lux	290 lux
Distance	35 ft	65 ft	100 ft	130 ft	165 ft	195 ft
Diameter	4.9 ft	9.1 ft	14 ft	18.2 ft	23.1 ft	27.3 ft
Illumination	850 fc	250 fc	110 fc	65 fc	39 fc	28 fc

### • Optics @ 16°

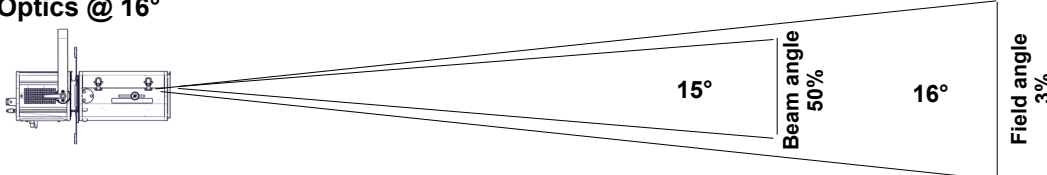

Beam intensity  
314 500 cd

Field lumens  
14 300 lm

Efficacy  
22 lm/W

CCT  
5 680 K

Distance	10 m	20 m	30 m	40 m	50 m	60 m
Diameter	2.8 m	5.6 m	8.4 m	11.2 m	14.1 m	16.9 m
Illumination	3 150 lux	790 lux	350 lux	200 lux	130 lux	90 lux
Distance	35 ft	65 ft	100 ft	130 ft	165 ft	195 ft
Diameter	9.8 ft	18.3 ft	28.1 ft	36.5 ft	46.4 ft	54.8 ft
Illumination	260 fc	75 fc	32 fc	19 fc	12 fc	9 fc

## Remote control

- Data protocol: USITT DMX512-A  
RDM / Art-Net / sACN

- Data IN connector: 5 pins XLR male + RJ45
- Data OUT connector: 5 pins XLR female



### • DMX chart:

#### Mode 1 (1 channels)

Dimmer

#### Mode 2 (2 channels)

Dimmer  
Dimmer fine

#### Mode 3 (5 channels)

Dimmer  
Strobe duration  
Strobe speed  
Response time  
Control mode

#### Mode 4 (6 channels)

Dimmer  
Master dimmer  
Strobe duration  
Strobe speed  
Response time  
Control mode

## Dimensions and weight

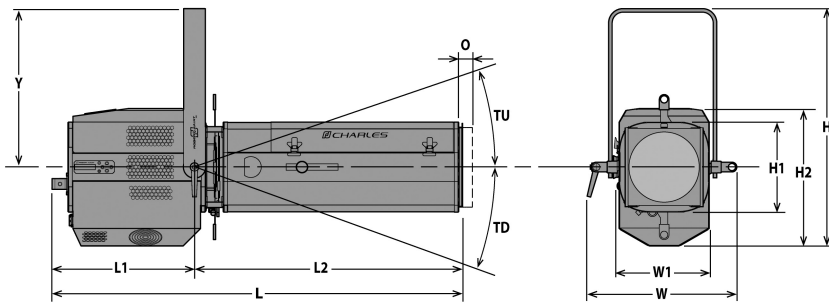

**Weight:** 35.2 kg (77.4 lbs)

Height	Length	Width	Yoke	Tilt	Option
H= 659 mm (25.9 in)	L= 1139 mm (44.8 in)	W= 368 mm (14.5 in)	Y= 440 mm (17.3 in)	TU= 68°	O= 25 mm (1 in)
H1= 250 mm (9.8 in)	L1= 395 mm (15.6 in)	W1= 250 mm (9.8 in)		TD= 90°	
H2= 381 mm (15 in)	L2= 744 mm (29.3 in)				

## Shipping

- **Weight :** kg (0 lbs)
- **Volume :** .35 m<sup>3</sup> (12.36 ft<sup>3</sup>)

## Installation

- **Minimum distance to illuminated surface:** 0.2 m ( 0.7 ft )
- **Operating position:**

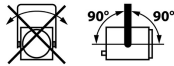

## Construction

- **Housing:** Steel sheet - Aluminium
- **Colour:** Black
- **Cooling:** Low noise variable fan
- **Maximum ambient temperature (Ta):** 40°C (104°F)
- **Maximum case temperature (Tc):** 65°C (149°F)
- **Total heat dissipation:** 2 184 BTU/h
- **Protection rating:** 20

## Electrical compatibility

- 220/230 V - 50 Hz
- 245 V - 50 Hz
- 110/120 V - 60 Hz
- 208 V - 60 Hz
- 220/230 V - 60 Hz
- 100 V - 50 Hz
- 100 V - 60 Hz
- Selector: automatic detection

## Power input



- **Type:** removeable power cord with Neutrik powerCON TRUE1 connector (included)
- **Cable:** H07RNF 3G1.5
- **Length:** 3 m (9,8 ft)
- **Power connector:** CEE 7/7 (2P+E NF/Schuko)

## Power consumption

Voltage	Frequency	Current	Power	Power factor
230 V	50 Hz	2.8 A	640 W	0,99
120 V	60 Hz	5.5 A	649 W	0,99
100 V	60 Hz	6.7 A	655 W	0,99

## Power Supply Unit

- **PSU:** Internal - Electronic PSU - Flicker free with PFC
- **Control:** Local / DMX
- **Protection:** -
- **Power thru:** Neutrik powerCON TRUE1 - Maximum of 5 units (230 V) / 2 units (120 V)

## Approvals



## Warranty

- **Period: 2 years**
- See General Sales Condition on website



## Acoustics

- **Noise level:** < 38,2 dB(A)













## Model

<b>961SX</b>	LED 600W Profile spot - 961SX Charles - Cool White - 8/16°
--------------	--

## Options

<b>CAV700</b>	Double slot front cassette for 215x215mm accessories	
<b>CAV700J</b>	Double slot front cassette for 245x245mm accessories	
<b>PCP1716A</b>	16A blue 2P+E 6h IEC60309 power connector	

## Accessories

<b>D8</b>	Shutter for SX series <b>4 included</b>	
<b>PF1000M2</b>	215x215mm metal filter holder <b>1 included</b>	
<b>SGUX</b>	Universal "A" size gobo-holder (metal, glass, frosted glass) <b>1 included</b>	
<b>IWSX755</b>	Drop-in iris (monoplane) with holder - Weight: ,26 Kg	
<b>G1000</b>	215x215mm safety grid	
<b>CAV700A</b>	Double slot front cassette for 215x215mm accessories - Weight: ,52 Kg	
<b>CAV700AJ</b>	Double slot front cassette for 245x245mm accessories - Weight: ,95 Kg	
<b>RPF960</b>	Front extension cassette for 215x215mm accessories with XLR7 fan (recommended for dark colours on 960SX) - Weight: 1,7 Kg	
<b>RPF960E</b>	Front extension cassette for 245x245mm accessories with XLR7 fan (recommended for dark colours on 960SX) - Weight: 1,7 Kg	
<b>VD120</b>	120x120mm frosted glass	
<b>FCD700</b>	Angled yoke - Weight: 1,62 Kg	
<b>876</b>	Hook clamp 40x10mm with 28mm M10 screw for Ø35 to 50mm pipes - SWL: 50Kg - Weight: 1,25 Kg	
<b>880</b>	Hook clamp 40x10mm with 28mm M10 screw for Ø50 to 63mm pipes - SWL: 50Kg - Weight: 1,36 Kg	

**CS2**

Safety cable Ø3 mm L= 600mm - SWL: 75 Kg

